

**ENGAGE**  
BUILDING PRODUCTS®

# FEPS - ASKING FOR THE BUSINESS

INTERNAL REP TRAINING

# THE OFFER

WE HAVE IDENTIFIED YOUR ORGANIZATION AS AN INDUSTRY LEADER — ONE THAT SETS THE STANDARD RATHER THAN FOLLOWS IT. FEPS WAS CREATED TO SUPPORT FIRST-MOVER PARTNERS WITH PRIORITY ACCESS TO THE BEST PRODUCTS, DEDICATED SERVICE, AND THE MOST COMPETITIVE PRICING STRUCTURES AVAILABLE. THIS LEVEL OF PARTNERSHIP IS INTENTIONALLY LIMITED; IT IS NOT DESIGNED FOR EVERYONE, NOR IS IT MEANT TO BE.

OUR OBJECTIVE IS TO JOINTLY INVEST IN THE SUCCESS OF PROJECTS THAT REDEFINE EXPECTATIONS FOR EXTERIOR PERFORMANCE, DURABILITY, AND ARCHITECTURAL CLARITY. BY COMBINING THE PROVEN SIMPLICITY OF THE FASTPLANK® INSTALLATION METHOD WITH THE LONG-TERM ADVANTAGES OF EXTRUDED ALUMINUM AND ARCHITECTURAL POWDER COATING, FEPS REPRESENTS A MEANINGFUL STEP FORWARD FOR BOTH SINGLE-FAMILY AND MULTIFAMILY CONSTRUCTION.

WITH THE RIGHT DEVELOPMENT PARTNER, ENGAGE IS PREPARED TO SUBSIDIZE MATERIAL COSTS THROUGH THE FEPS PROGRAM (FULL EXTERIOR PRODUCT SOLUTION), OFFERING A UNIFIED, PER-SQUARE-FOOT EXTERIOR PACKAGE DESIGNED TO ALIGN WITH EXISTING CLADDING BUDGETS. THIS IS MORE THAN A SUPPLY AGREEMENT — IT IS A STRATEGIC PARTNERSHIP INTENDED TO INFLUENCE THE BROADER MARKET AND SET A NEW BENCHMARK FOR EXTERIOR CONSTRUCTION.

# FEPS FOR BUILDERS AND DEVELOPERS

**ENGAGE**  
BUILDING PRODUCTS

BUILDER'S LOGO

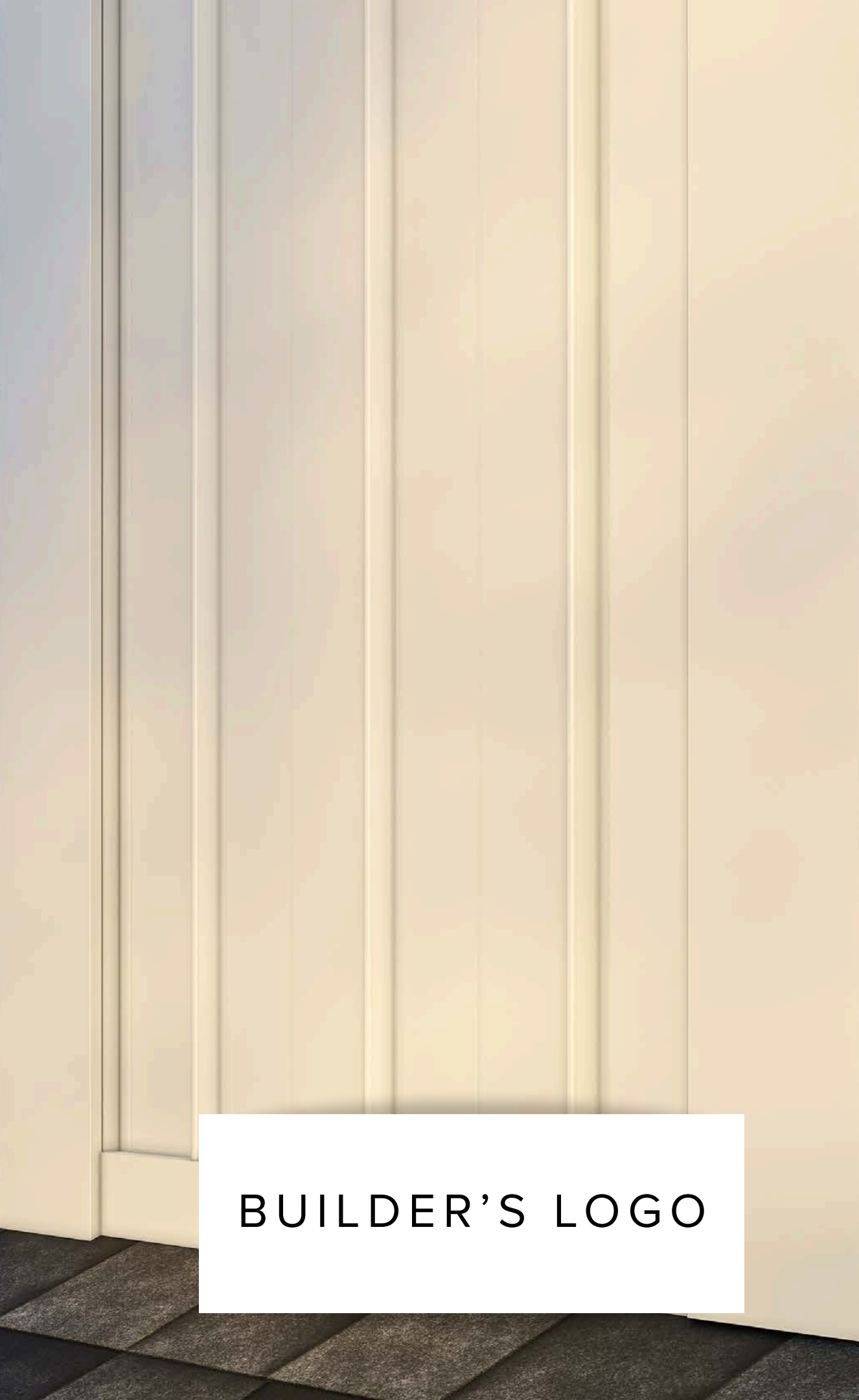
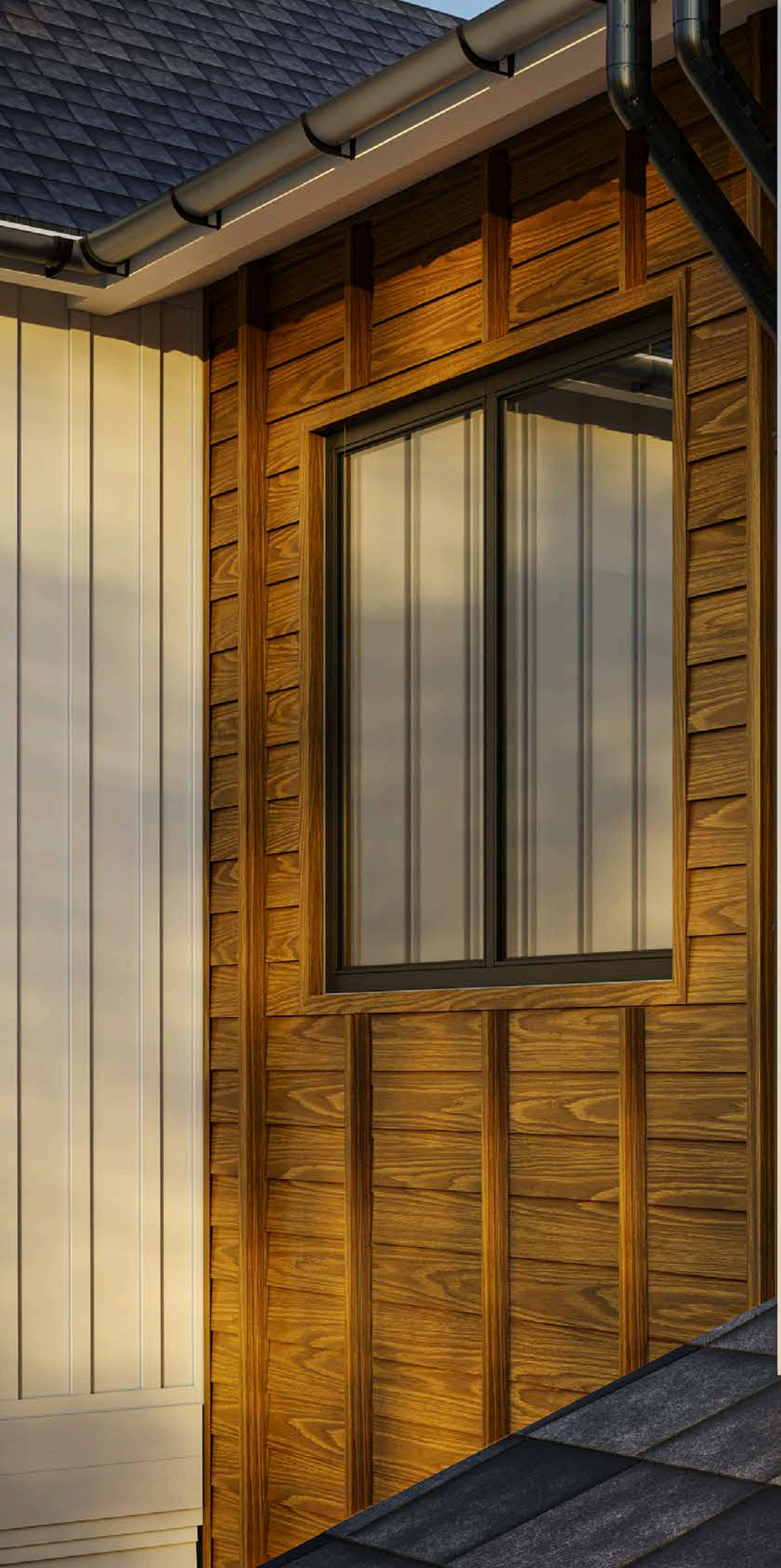

**ENGAGE**  
BUILDING PRODUCTS®

BUILDER'S LOGO



**ENGAGE**  
BUILDING PRODUCTS®



BUILDER'S LOGO



**ENGAGE**  
BUILDING PRODUCTS®



BUILDER'S LOGO



**ENGAGE**  
BUILDING PRODUCTS®

BUILDER'S LOGO



**ENGAGE**  
BUILDING PRODUCTS®

BUILDER'S LOGO

# HOW IT WORKS

## THE 7 STEPS OF FEPS

1. Discuss Budget
2. Custom Design
3. Product Testing
4. Connect You With The Right Suppliers
5. We Manufacture, Stage, and Ship Product
6. On-Site Install Training
7. FEPS - Everything, Everywhere, All At Once

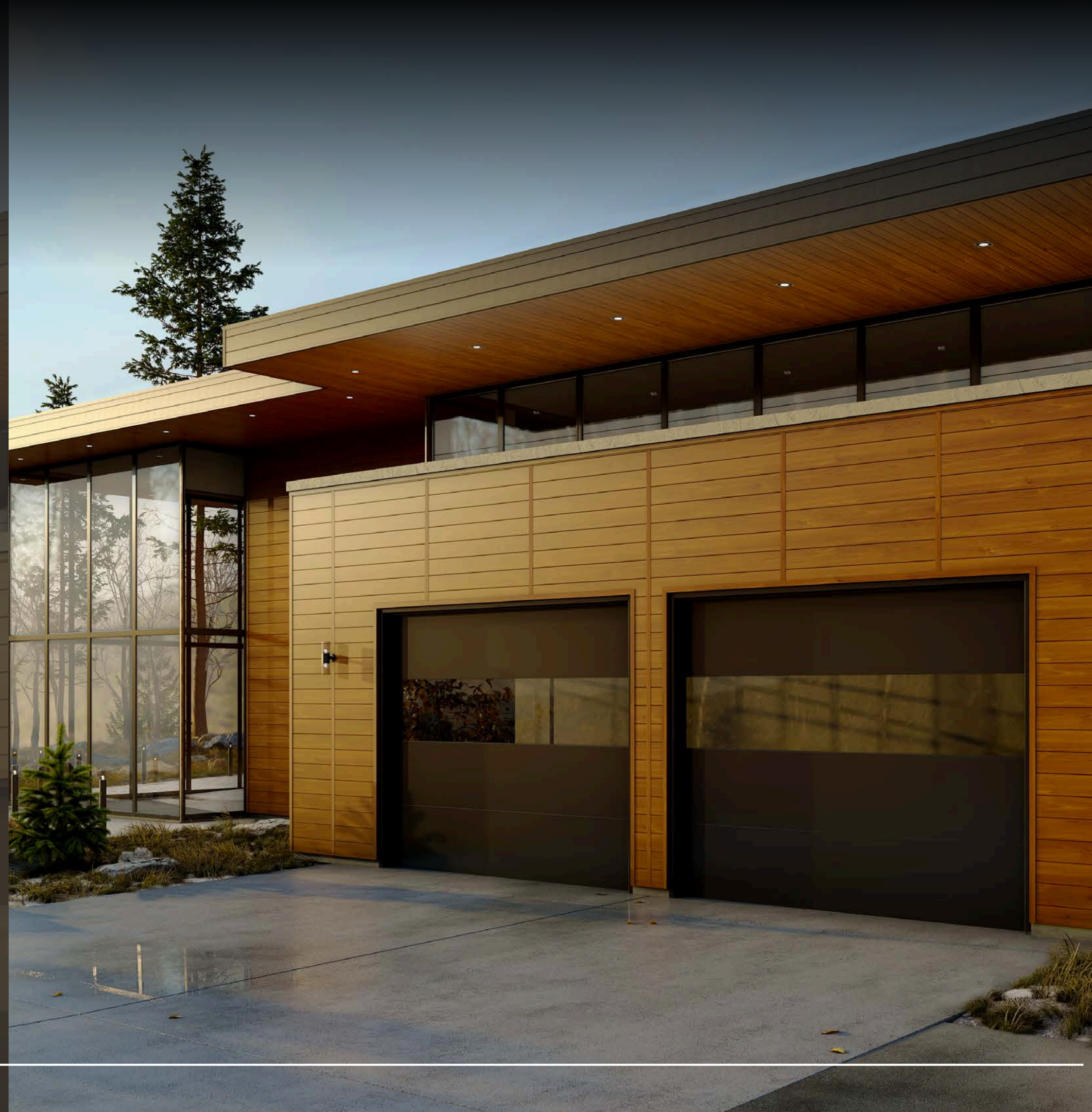

# 1. DISCUSS BUDGET

WE RECOGNIZE THAT CURRENT MARKET CONDITIONS DEMAND DISCIPLINE, AND INCREASING BUDGETS IS NEITHER REALISTIC NOR DESIRABLE. OUR OBJECTIVE IS NOT TO ASK FOR MORE, BUT TO DELIVER GREATER VALUE WITHIN YOUR EXISTING EXTERIOR CLADDING BUDGET. TO ACHIEVE THIS, WE ASK FOR TRANSPARENCY AROUND THE FULL SIDING SCOPE AND BUDGET. IN RETURN, WE COMMIT TO SUPPLYING AS MUCH OF THE EXTERIOR ENVELOPE AS POSSIBLE THROUGH FEPS, OPTIMIZING PRODUCT MIX AND MARGIN TO ALIGN WITH YOUR DESIGN GOALS AND FINANCIAL TARGETS. AN OPEN AND HONEST DISCUSSION AROUND BUDGET GIVES US A CLEAR BENCHMARK TO WORK TOWARD — ENABLING A SOLUTION THAT WORKS FOR BOTH SIDES.



## 2. CUSTOM DESIGN

WE HAVE ALREADY DEVELOPED A WIDE RANGE OF CLADDING OPTIONS BUILT AROUND THE PROVEN FASTPLANK® INSTALLATION SYSTEM, OFFERING FLEXIBILITY WITHOUT COMPLEXITY. HOWEVER, WHEN A PROJECT CALLS FOR SOMETHING TRULY UNIQUE, WE ARE FULLY PREPARED TO DESIGN CUSTOM SOLUTIONS AT YOUR REQUEST. WE BELIEVE STRONGLY THAT THE ADVANTAGES OF A FULLY EXTRUDED ALUMINUM EXTERIOR — INSTALLED ON A RAINDOOR AND FINISHED IN ULTRA-DURABLE POWDER COATING — ARE IMMEDIATELY VISIBLE AND TANGIBLE. THESE BENEFITS TRANSLATE DIRECTLY TO HOMEOWNER AND TENANT PERCEPTION, ELEVATING BOTH EXPERIENCE AND LONG-TERM VALUE.



# 3. PRODUCT TESTING

FEPS IS BUILT ON THE SAME RIGOROUS TESTING AND PERFORMANCE STANDARDS THAT DEFINE THE FASTPLANK® SYSTEM. THIS INCLUDES INDUSTRY-LEADING WIND-LOAD PERFORMANCE AND NON-COMBUSTIBILITY, WHILE INTRODUCING THE ENHANCED DURABILITY AND LONG-TERM FINISH PERFORMANCE OF ARCHITECTURAL POWDER COATING. THE RESULT IS A FULLY TESTED EXTERIOR SOLUTION THAT DELIVERS CONFIDENCE ACROSS PERFORMANCE, SAFETY, AND LONGEVITY — WITHOUT COMPROMISE.



# 4. CONNECT YOU WITH THE RIGHT SUPPLIERS

ONCE A TARGET BUDGET IS ESTABLISHED, OUR PRIORITY BECOMES ALIGNMENT — NOT ONLY BETWEEN DESIGN AND COST, BUT ACROSS THE ENTIRE SUPPLY CHAIN. WE WORK TO CONNECT YOU WITH THE RIGHT CHANNEL PARTNER: A DEALER WHO UNDERSTANDS THE VISION, SUPPORTS THE PRICING STRUCTURE, AND CAN DELIVER STRONG LOCAL SERVICE. THIS ALIGNMENT ENSURES THE PROJECT IS SUPPORTED CONSISTENTLY FROM SPECIFICATION THROUGH DELIVERY, WITHOUT FRICTION OR MISALIGNMENT.



# 5. WE MANUFACTURE, STAGE, SHIP

CLEAR COMMUNICATION AND SCHEDULING ARE ESSENTIAL TO THE SUCCESS OF THIS PARTNERSHIP. WE AIM TO BE CLOSELY ALIGNED WITH YOUR CONSTRUCTION TIMELINE, ENSURING MATERIALS ARE MANUFACTURED, STAGED, AND PREPARED WELL IN ADVANCE OF ON-SITE INSTALLATION. BY COORDINATING PRODUCTION AND DELIVERY WITH YOUR SCHEDULE, WE HELP REDUCE SITE CONGESTION, STORAGE CHALLENGES, AND DELAYS — SUPPORTING SMOOTHER EXECUTION OVERALL.



# 6.ON-SITE INSTALL TRAINING

THIS PARTNERSHIP REPRESENTS A MEANINGFUL INVESTMENT, AND FOR THAT INVESTMENT TO SUCCEED, THE FINISHED RESULT MUST BE EXCEPTIONAL. TO ENSURE THIS, WE PROVIDE HANDS-ON INSTALLATION TRAINING AND ONGOING SUPPORT THROUGHOUT THE PROJECT. BY INVOLVING OUR IN-HOUSE INSTALLATION TECHNICIANS EARLY, WE HELP CREWS EXECUTE THE SYSTEM CORRECTLY, EFFICIENTLY, AND CONSISTENTLY. THE GOAL IS A FINISHED EXTERIOR THAT BOTH TEAMS ARE PROUD TO SHOWCASE.





# 7.FEPS – EVERYTHING, EVERYWHERE, ALL AT ONCE

NOW THAT YOU HAVE SEEN THE ADVANTAGES OF THE FEPS PROGRAM – FROM DESIGN FLEXIBILITY AND PERFORMANCE TO EXECUTION EFFICIENCY – OUR INTENTION IS TO CONTINUE THE PARTNERSHIP. WE SEE OPPORTUNITIES TO EXPAND THIS APPROACH ACROSS FUTURE PROJECTS, LEVERAGING THE MARKETING, OPERATIONAL, AND ARCHITECTURAL BENEFITS THAT COME WITH AN INDUSTRY STEP-CHANGE. MORE VALUE, BETTER PERFORMANCE, CLEANER DESIGN, HIGHER PERCEIVED QUALITY, AND LEADING TECHNOLOGY – FEPS IS BUILT TO DELIVER ALL OF IT, AT SCALE.

# SYSTEM VERSATILITY

ONE ECOSYSTEM. MULTIPLE PROFILES.

- 6" V-NOTCH
- BOARD & BATTEN
- 8/16" LAP
- SHALLOW FLUTED
- DEEP FLUTED
- ARCHITECTURAL FINIS
- 3" DOUBLE V-NOTCH
- INVISI-LINE WITH REVEALS
- 2-PIECE FLUTED
- VARIABLE SQUARE NOTCH
- STANDING SEAM
- CHEVRON
- QUICKPANEL 2.0



# 6" V-NOTCH

There are designs that define an era, and those that transcend it. Rooted in the enduring cladding traditions of early North American architecture, the 6" V-Notch has been meticulously re-engineered to bring architectural depth, disciplined geometry, and lasting integrity to modern design.



# BOARD & BATTEN

Defined by its strong vertical rhythm and sculpted interplay of light and shadow, Board & Batten brings architectural texture and visual order to any elevation. The FEPS system transforms this traditional form through clean, uninterrupted lines and exacting proportion, creating façades that feel structured yet inviting. Whether anchoring a modern farmhouse or articulating a contemporary multifamily design, Board & Batten introduces balance, depth, and timeless composure, a quiet strength expressed through form.

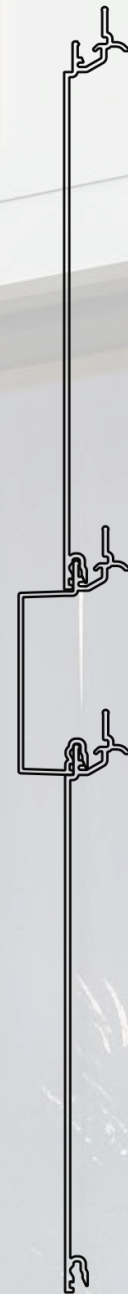

# 8/16" LAP

Every detail of the 8/16" Lap communicates strength, symmetry, and permanence. This is the profile that defines the FEPS standard, solid, balanced, and architectural in every sense. Its flawless shadow lines and tactile rigidity project confidence, delivering a refined simplicity that commands attention without distraction.



# SHALLOW FLUTED

Soft light. Subtle motion. The Shallow Fluted profile captures the quiet elegance of changing light, transforming walls into living surfaces that shift tone and depth throughout the day. It's understated architectural artistry, is dynamic yet tranquil.



# DEEP FLUTED

Bold and architectural, the Deep Fluted profile creates façades with presence. Its pronounced vertical ribs catch and shape light, turning large surfaces into expressions of balance and intent. Strong yet refined, it brings sculptural energy to modern exteriors.



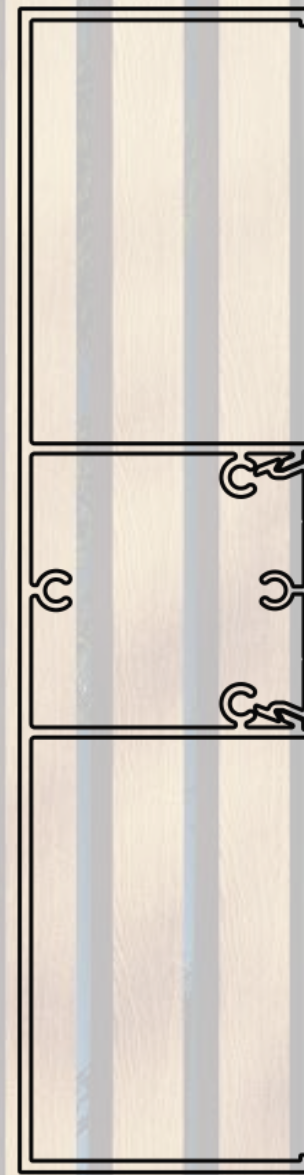
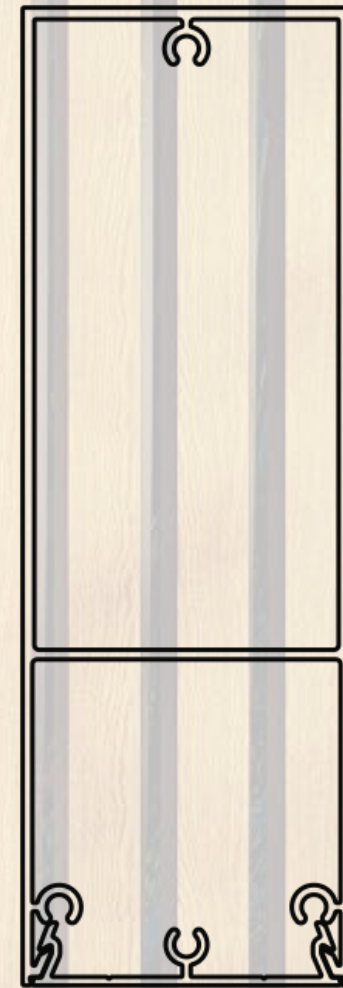

# ARCHITECTURAL FINS

Form meets function in the FEPS Architectural Fins — a design statement that blends elegance, performance, and longevity. Whether fixed or floating, these linear elements define façades with depth and rhythm, turning sunlight into architectural art.

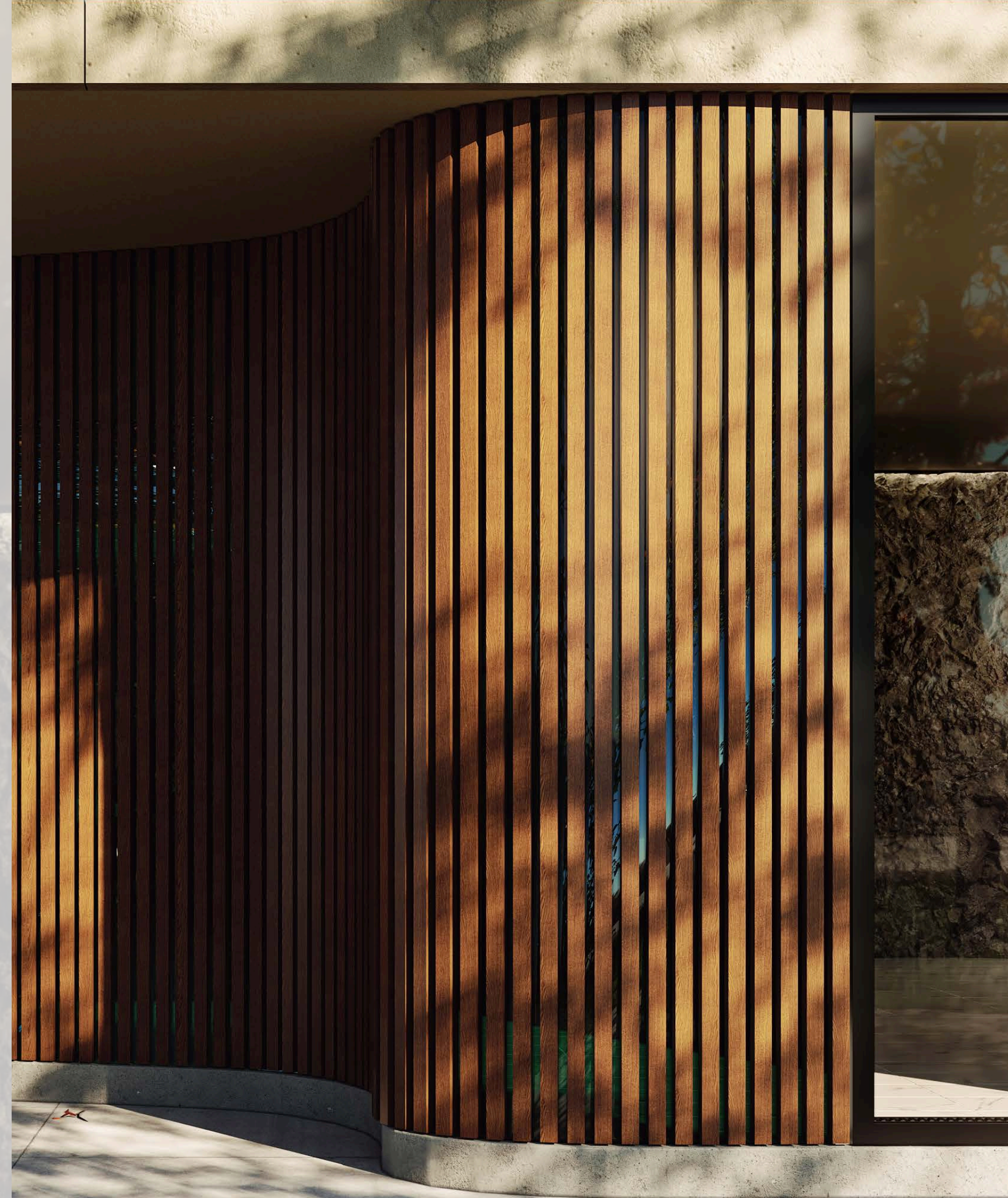

# 3" DOUBLE V-NOTCH

Architecture lives in rhythm; the dialogue between light, shadow, and proportion that gives a façade its soul. The 3" Double V-Notch was conceived to compose that rhythm with precision. Drawing inspiration from the timeless geometry of farmhouse wainscot and refined through advanced extrusion engineering, it delivers a measured dual-shadow cadence that feels intentional, balanced, and undeniably sophisticated. A profile where movement meets restraint, and design becomes poetry in form.



# INVISI-LINE WITH REVEALS

Great architecture balances aspiration and practicality. Invisi-Line™ with Reveals was designed for projects that demand refined aesthetics and lasting durability, without exceeding budget targets. Delivering the elevated look of ACM panels at a fraction of the cost, it achieves deep shadow lines, sharp geometry, and a composed, architectural presence.



## 2-PIECE FLUTED

Inspired by Scandinavian minimalism and old-world craftsmanship, the 2-Piece Fluted Plank combines warmth, symmetry, and precision. It evokes the texture of carved wood in a modern, enduring form, understated, tactile, and timeless.

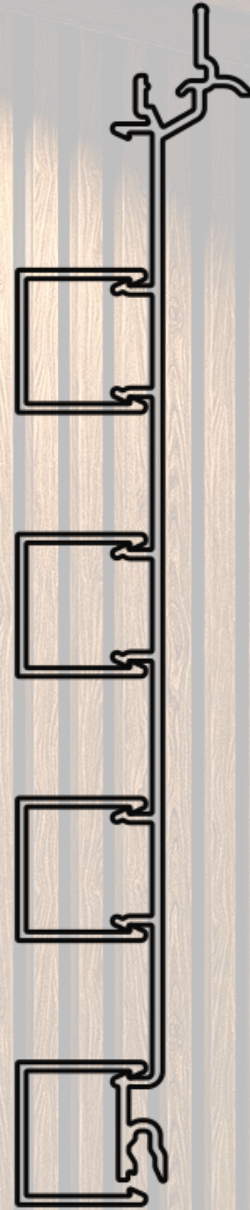

# VARIABLE SQUARE NOTCH

Industrial meets intentional. The Variable Square Notch channels the raw energy of shipping-container design into a refined architectural language. Its interplay of square recesses and linear precision evokes strength, purpose, and modern urban character.

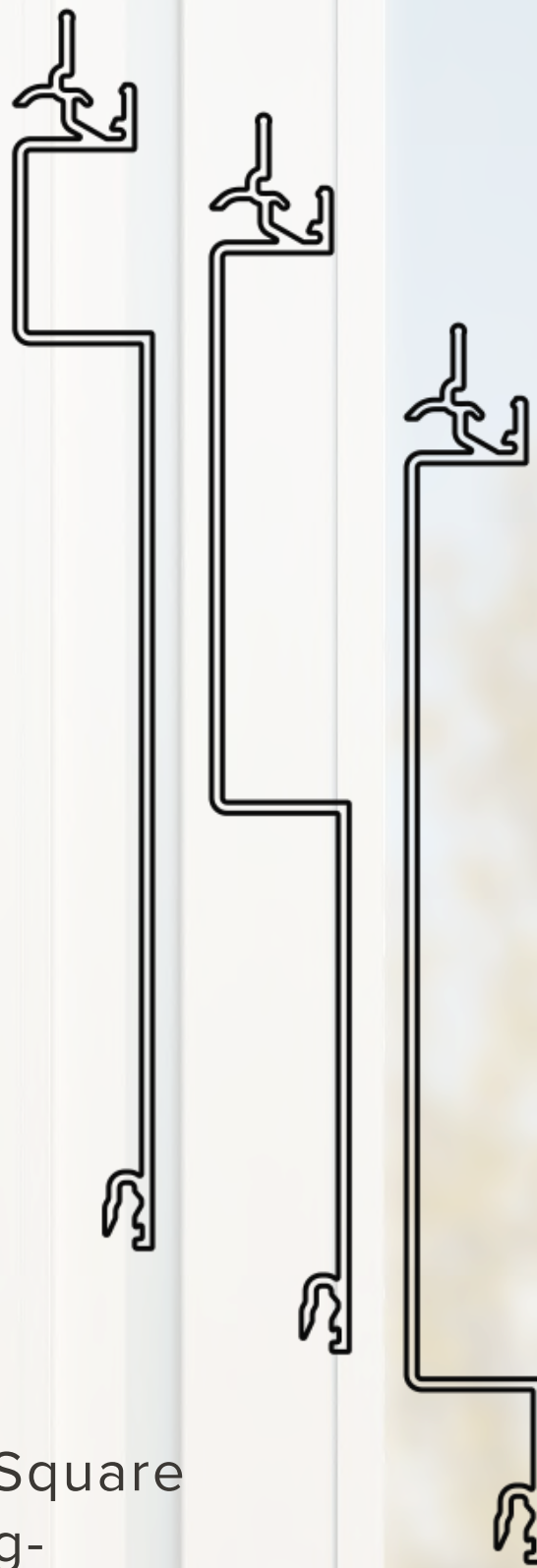

# STANDING SEAM

Industrial elegance, perfected. The FEPS Standing Seam captures the precision and uniformity of extruded metal in a profile that embodies strength, refinement, and modern architectural clarity.



# CHEVRON

Drama through precision — the Chevron profile reimagines corrugated metal as architectural luxury. Its deep V-shaped geometry captures light and shadow in constant motion, creating façades that shift character from dawn to dusk.

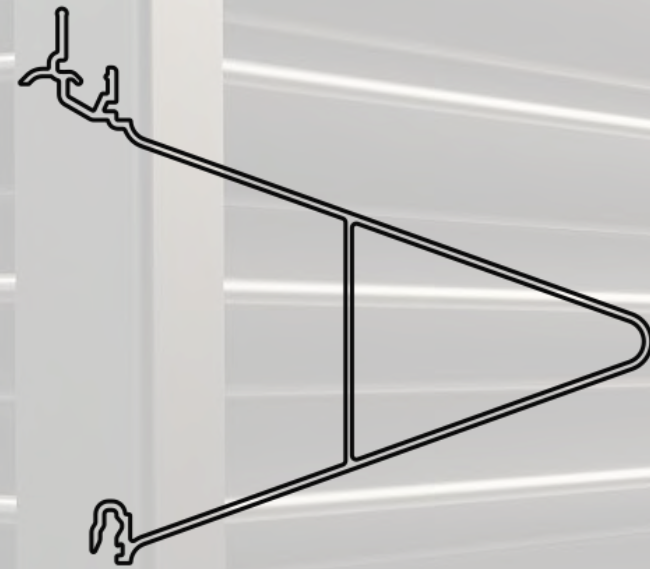

REVEAL

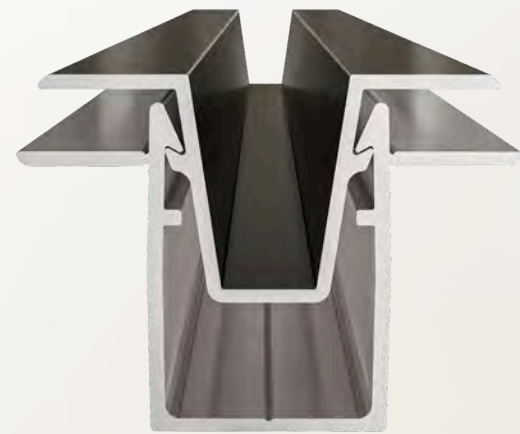

STREAMLINE

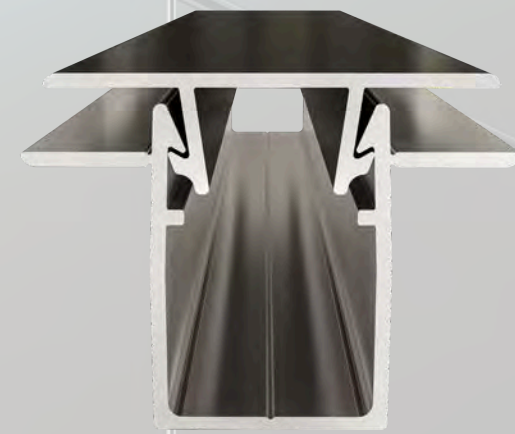

# QUICKPANEL 2.0

QuickPanel® 2.0 redefines what's possible in exterior design, bringing the prestige of high-end metal façades to large-scale, real-world projects. Inspired by the sophistication of route-and-return systems seen on flagship commercial architecture, it delivers that same sleek refinement without the complexity or cost. Each panel captures light with subtle precision, creating façades that feel intentional, modern, and enduring. It's a system designed for builders who value both form and function, where elegance meets efficiency in perfect balance.



# LIMITLESS DESIGN EXPRESSION

- 1,500+ RAL COLORS
- CUSTOM COLORMATCH®
- 24 SPECIALTY WOODGRAIN FINISHES
- PROFILES FOR EVERY ARCHITECTURAL  
STYLE
- 20 YEAR FINISH WARRANTY

## COLOR OPTIONS

### Stock Woodgrains

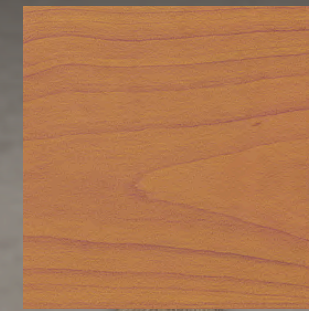

Light Cherry



Dark Fir

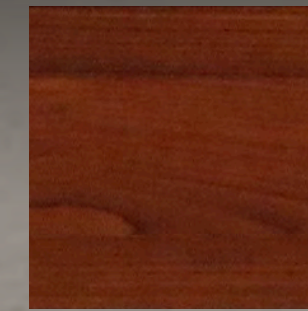

Dark Cherry

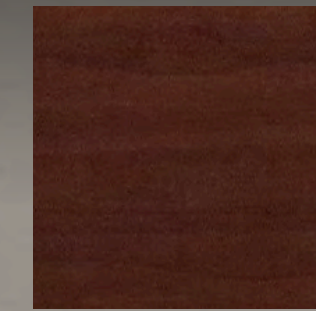

Dark Walnut

### Stock Solids

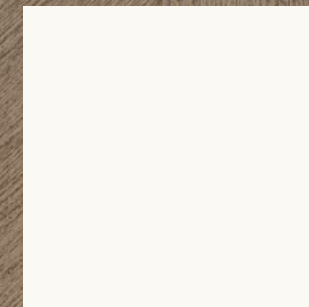

Bone White

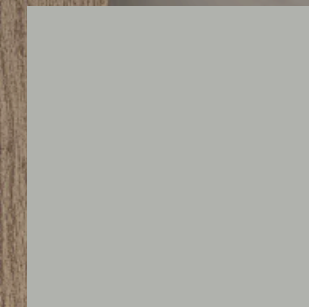

Cadet Grey



Charcoal

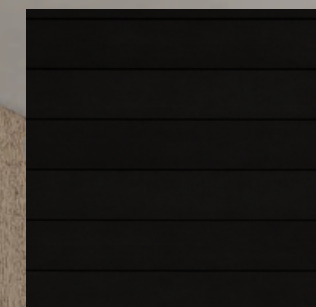

Classic Black

Custom solid colors with  
ColorMatch® (additional  
lead times apply)



All finishes shown are reproductions and may differ slightly  
from actual products. Product samples are available for  
color verification and approval.

All FastPlank® products come  
with 50-year Product warranty  
and 20-year Finish warranty



# LIMITLESS DESIGN EXPRESSION

- CONTEMPORARY MULTIFAMILY
- MODERN FARMHOUSE
- INDUSTRIAL MIXED-USE

## SPECIALTY WOODGRAINS

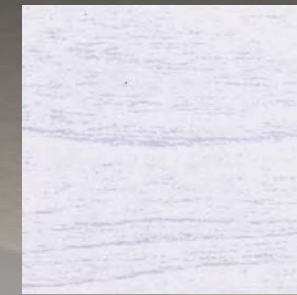

Western White Maple

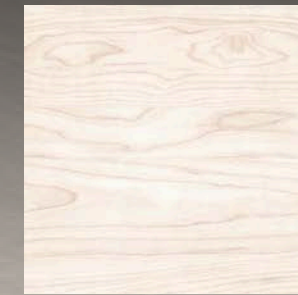

Arctic White Oak

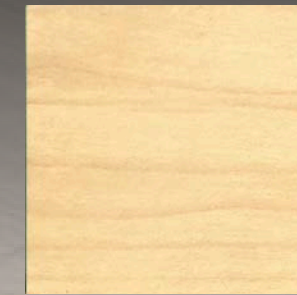

Belgium Pear



Light Mahogany

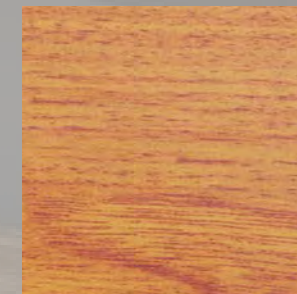

Pecan Hazelwood

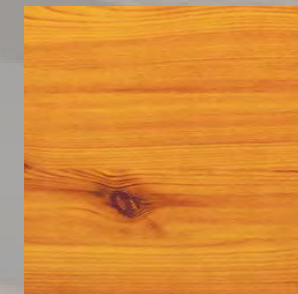

Knotty Pine

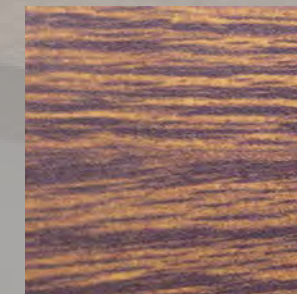

Hickory Oak

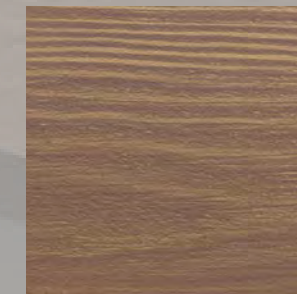

Autumn Chestnut

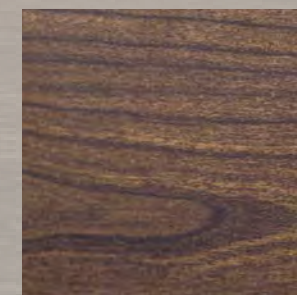

Cafe Noir

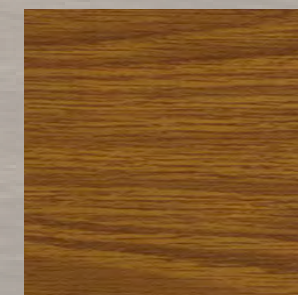

Mocha Oak

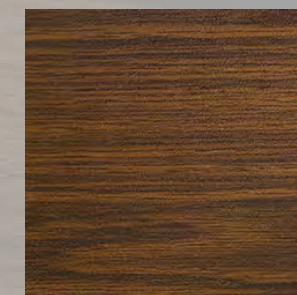

Chestnut Brown Oak

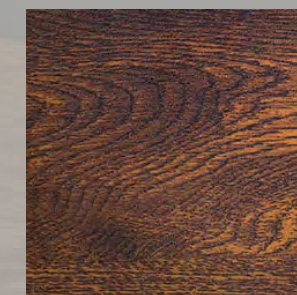

European Walnut

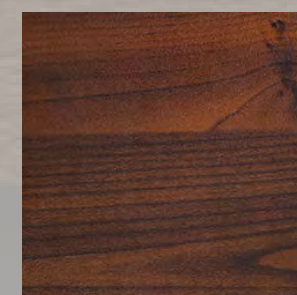

Beechwood



Ironwood

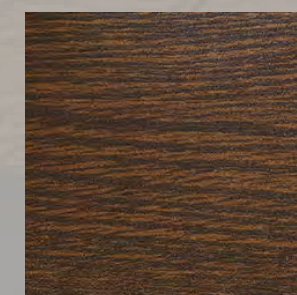

Dark Zebra



Italian Rosewood



African Walnut



National Grey



Fossil Grey



Smoked Ash



# COLORMATCH™ PROGRAM

- UNLIMITED CUSTOM COLOR CAPABILITY  
ACROSS ALL SYSTEMS
- MATCH BRAND STANDARDS, PAINT CODES,  
OR BESPOKE FINISHES
- CONSISTENT, REPEATABLE RESULTS AT ANY  
PROJECT SCALE



# The Future of Façades

Tailored for You.  
Built for The Future.  
Perfected by Engage.

**ENGAGE**  
BUILDING PRODUCTS®

BUILDER'S LOGO